

General-purpose Relay

G2R-□-S

CSM_G2R-_-S_DS_E_3_1

Slim and Space-saving Power Plug-in Relay

- Lockable test button models now available.
- Built-in mechanical operation indicator.
- Provided with nameplate.
- AC type is equipped with a coil-disconnection self-diagnostic function (LED type).
- High switching power (1-pole: 10 A).
- Environment-friendly (Cd, Pb free).
- Wide range of Sockets also available.

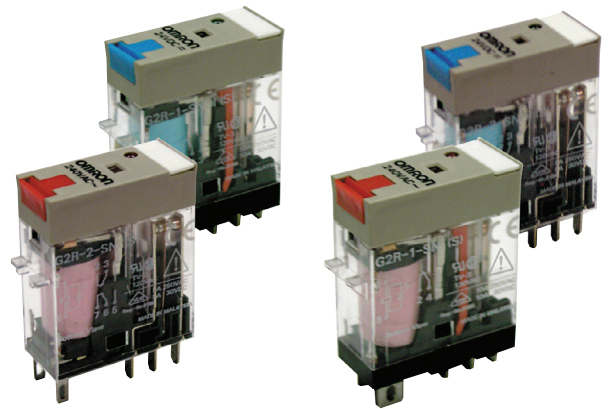

Model Number Structure

Model Number Legend

G2R - - -

1 2 3 4 5 6 7

1. Relay Function

Blank: General-purpose

2. Number of Poles

1: 1 pole
2: 2 poles

3. Contact Form

Blank: SPDT

4. Contact Type

Blank: Single

5. Terminals

S: Plug-in

6. Classification

Blank: General-purpose
N: LED indicator
D: Diode
ND: LED indicator and diode
NI: LED indicator with test button
NDI: LED indicator and diode with test button

7. Rated Coil Voltage

Ordering Information

List of Models

	Classification	Enclosure rating	Coil ratings	Contact form	
				SPDT	DPDT
Plug-in terminal	General-purpose	Unsealed	AC/DC	G2R-1-S	G2R-2-S
	LED indicator			G2R-1-SN	G2R-2-SN
	LED indicator with test button			G2R-1-SNI (S)	G2R-2-SNI (S)
	Diode		DC	G2R-1-SD	G2R-2-SD
	LED indicator and diode			G2R-1-SND	G2R-2-SND
	LED indicator and diode with test button			G2R-1-SNDI (S)	G2R-2-SNDI (S)

Note: When ordering, add the rated coil voltage and "(S)" to the model number. Rated coil voltages are given in the coil ratings table.

Example: G2R-1-S 12 VDC (S) — New model
 Rated coil voltage

Accessories (Order Separately)

Connecting Sockets

Applicable Relay model	Track/surface-mounting Socket		Back-mounting Socket	
	Screwless clamp terminal	Screw terminal	Terminals	Model
1 pole G2R-1-S(N)(D)(ND)(NI)(NDI)	• P2RF-05S (See note.) + (P2CM-S (option))	• P2RF-05-E • P2RF-05	PCB terminals	P2R-05P, P2R-057P
			Solder terminals	P2R-05A
2 poles G2R-2-S(N)(D)(ND)(NI)(NDI)	• P2RF-08S (See note.) + (P2CM-S (option))	• P2RF-08-E • P2RF-08	PCB terminals	P2R-08P, P2R-087P
			Solder terminals	P2R-08A

Note: Use of the P2CM Clip & Release Lever is recommended to ensure stable mounting.

Accessories for Screwless Clamp Terminal Socket (Option)

Name	Model
Clip & Release Lever	P2CM-S
Nameplate	R99-11 Nameplate for MY
Socket Bridge	P2RM-SR (for AC), P2RM-SB (for DC)

Mounting Tracks

Applicable Socket	Description	Model
Track-connecting Socket	Mounting track	50 cm (ℓ) x 7.3 mm (t): PFP-50N 1 m (ℓ) x 7.3 mm (t): PFP-100N 1 m (ℓ) x 16 mm (t): PFP-100N2
	End plate	PFP-M
	Spacer	PFP-S
Back-connecting Socket	Mounting plate	P2R-P*

* Used to mount several P2R-05A and P2R-08A Connecting Sockets side by side.

Specifications

Coil Ratings

Rated voltage	Rated current*		Coil resistance*	Coil inductance (H) (ref. value)		Must operate voltage	Must release voltage	Max. voltage	Power consumption (approx.)	
	50 Hz	60 Hz		Armature OFF	Armature ON					
AC	24 V	43.5 mA	37.4 mA	253 Ω	0.81	1.55	80% max.	30% max.	110%	0.9 VA at 60 Hz
	110 V	9.5 mA	8.2 mA	5,566 Ω	13.33	26.83				
	120 V	8.6 mA	7.5 mA	7,286 Ω	16.13	32.46				
	230 V	4.4 mA	3.8 mA	27,172 Ω	72.68	143.90				
	240 V	3.7 mA	3.2 mA	30,360 Ω	90.58	182.34				

Rated voltage	Rated current*		Coil resistance*	Coil inductance (H) (ref. value)		Must operate voltage	Must release voltage	Max. voltage	Power consumption (approx.)
	50 Hz	60 Hz		Armature OFF	Armature ON				
DC	6 V	87.0 mA	69 Ω	0.25	0.48	70% max.	15% min.	110%	0.53 W
	12 V	43.2 mA	278 Ω	0.98	2.35				
	24 V	21.6 mA	1,113 Ω	3.60	8.25				
	48 V	11.4 mA	4,220 Ω	15.2	29.82				

* The rated current and coil resistance are measured at a coil temperature of 23°C with tolerances of ±10%.

Contact Ratings

Number of poles	1 pole		2 poles	
Load	Resistive load ($\cos\phi = 1$)	Inductive load ($\cos\phi = 0.4$; L/R = 7 ms)	Resistive load ($\cos\phi = 1$)	Inductive load ($\cos\phi = 0.4$; L/R = 7 ms)
Rated load	10 A at 250 VAC; 10 A at 30 VDC	7.5 A at 250 VAC; 5 A at 30 VDC	5 A at 250 VAC; 5 A at 30 VDC	2 A at 250 VAC; 3 A at 30 VDC
Rated carry current	10 A		5 A	
Max. switching voltage	440 VAC, 125 VDC		380 VAC, 125 VDC	
Max. switching current	10 A		5 A	
Max. switching power	2,500 VA, 300 W	1,875 VA, 150 W	1,250 VA, 150 W	500 VA, 90 W
Failure rate (reference value)	100 mA at 5 VDC		10 mA at 5 VDC	

Note: P level: $\lambda_{60} = 0.1 \times 10^{-6}/\text{operation}$

Characteristics

Item	1 pole	2 poles
Contact resistance	100 m Ω max.	
Operate (set) time	15 ms max.	
Release (reset) time	AC: 10 ms max.; DC: 5 ms max. (w/built-in diode: 20 ms max.)	AC: 15 ms max.; DC: 10 ms max. (w/built-in diode: 20 ms max.)
Max. operating frequency	Mechanical: 18,000 operations/hr Electrical: 1,800 operations/hr (under rated load)	
Insulation resistance	1,000 M Ω min. (at 500 VDC)	
Dielectric strength	5,000 VAC, 50/60 Hz for 1 min between coil and contacts*; 1,000 VAC, 50/60 Hz for 1 min between contacts of same polarity	5,000 VAC, 50/60 Hz for 1 min between coil and contacts*; 3,000 VAC, 50/60 Hz for 1 min between contacts of different polarity 1,000 VAC, 50/60 Hz for 1 min between contacts of same polarity
Vibration resistance	Destruction: 10 to 55 to 10 Hz, 0.75 mm single amplitude (1.5 mm double amplitude) Malfunction: 10 to 55 to 10 Hz, 0.75 mm single amplitude (1.5 mm double amplitude)	
Shock resistance	Destruction: 1,000 m/s ² Malfunction: 200 m/s ² when energized; 100 m/s ² when not energized	
Endurance	Mechanical: AC coil: 10,000,000 operations min.; DC coil: 20,000,000 operations min. (at 18,000 operations/hr) Electrical: 100,000 operations min. (at 1,800 operations/hr under rated load) (DC coil type)	
Ambient temperature	Operating: -40°C to 70°C (with no icing or condensation)	
Ambient humidity	Operating: 5% to 85%	
Weight	Approx. 21 g	

Note: Values in the above table are the initial values.

*4,000 VAC, 50/60 Hz for 1 minute when the P2R-05A or P2R-08A Socket is mounted.

Approved Standards

UL 508 (File No. E41643)

Model	Contact form	Coil ratings	Contact ratings	Operations
G2R-1-S	SPDT	5 to 110 VDC 5 to 240 VAC	10 A, 30 VDC (resistive) 10 A, 250 VAC (general use) TV-3 (NO contact only)	6 x 10 ³
G2R-2-S	DPDT		5 A, 30 VDC (resistive) 5 A, 250 VAC (general use) TV-3 (NO contact only)	6 x 10 ³

CSA 22.2 No.0, No.14 (File No. LR31928)

Model	Contact form	Coil ratings	Contact ratings	Operations
G2R-1-S	SPDT	5 to 110 VDC 5 to 240 VAC	10 A, 30 VDC (resistive) 10 A, 250 VAC (general use) TV-3 (NO contact only)	6 x 10 ³
G2R-2-S	DPDT		5 A, 30 VDC (resistive) 5 A, 250 VAC (general use) TV-3 (NO contact only)	6 x 10 ³

IEC/VDE (EN61810)

Contact form	Coil ratings	Contact ratings	Operations
1 pole	6, 12, 24, 48 VDC 24, 110, 120, 230, 240 VAC	5 A, 440 VAC ($\cos\phi = 1.0$) 10 A, 250 VAC ($\cos\phi = 1.0$) 10 A, 30 VDC (0 ms)	100 x 10 ³
2 poles	6, 12, 24, 48 VDC 24, 110, 120, 230, 240 VAC	5 A, 250 VAC ($\cos\phi = 1.0$) 5 A, 30 VDC (0 ms)	100 x 10 ³

LR

Number of poles	Coil ratings	Contact ratings	Operations
1 pole	5 to 110 VDC 5 to 240 VDC	10 A, 250 VAC (general use) 7.5 A, 250 VAC (PF0.4) 10 A, 30 VDC (resistive) 5A, 30VDC (L/R=7ms)	100 x 10 ³
2 poles	5 to 110 VDC 5 to 240 VDC	5 A, 250 VAC (general use) 2 A, 250 VAC (PF0.4) 5 A, 30 VDC (resistive) 3A, 30VDC (L/R=7ms)	100 x 10 ³

Engineering Data

Maximum Switching Power

Plug-in Relays

G2R-1-S

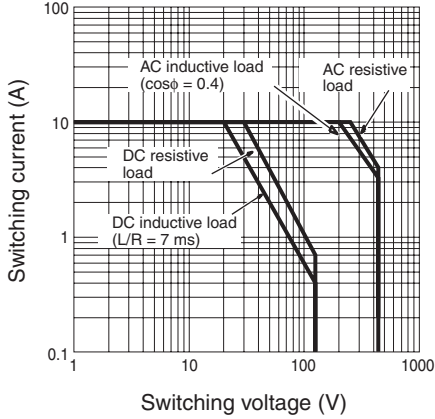

G2R-2-S

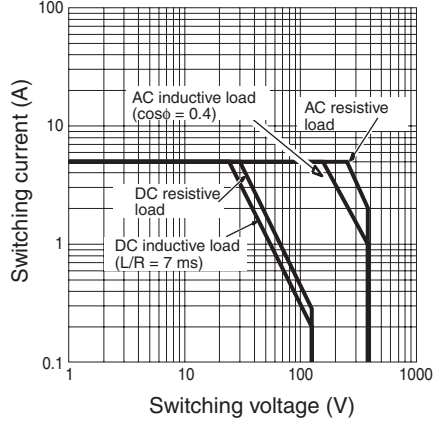

Endurance

Plug-in Relays

G2R-1-S

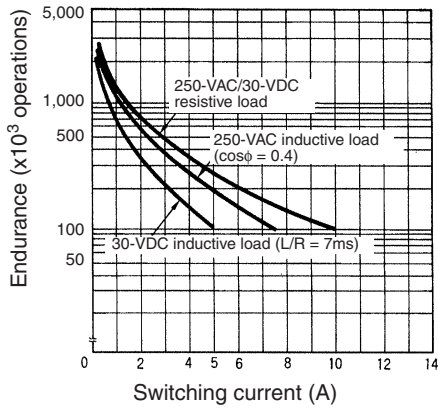

G2R-2-S

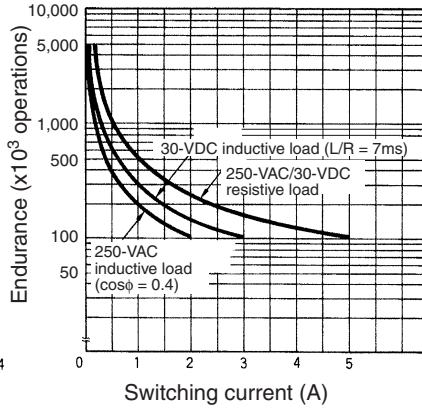

Ambient Temperature vs Maximum Coil Voltage

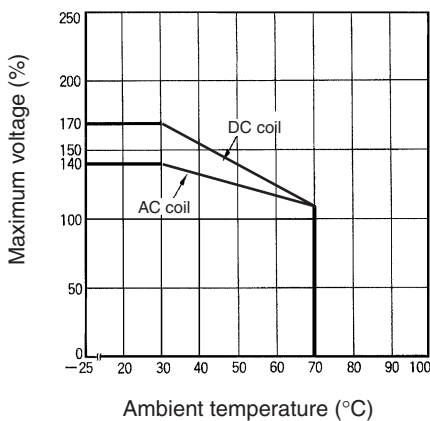

Note: The maximum voltage refers to the maximum value in a varying range of operating power voltage, not a continuous voltage.

Dimensions

Note: All units are in millimeters unless otherwise indicated.

Relays with Plug-in Terminals

SPDT Relays

G2R-1-S, G2R-1-SN, G2R-1-SNI (S)
 G2R-1-SD, G2R-1-SND, G2R-1-SNDI (S)

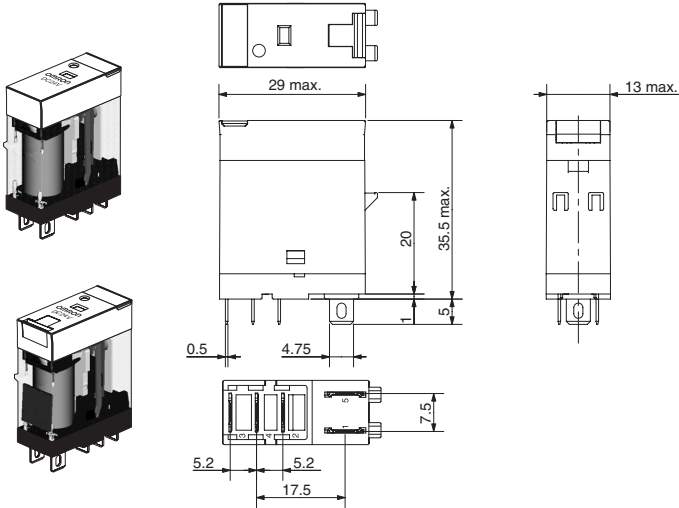

Terminal Arrangement/Internal Connections (Bottom View)

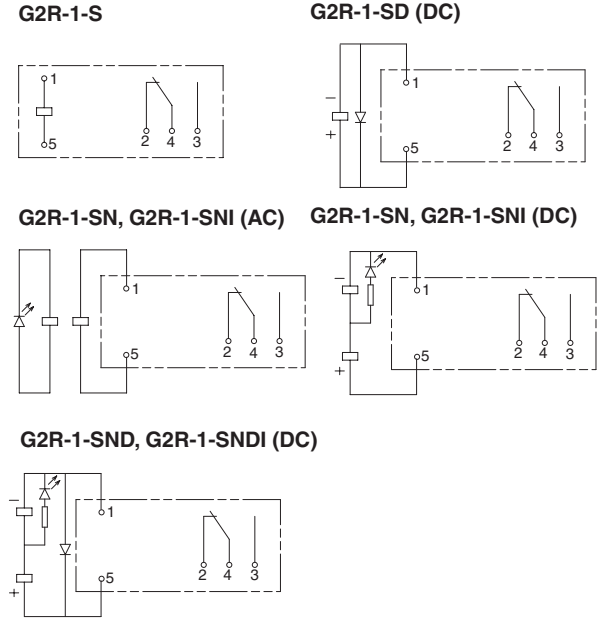

DPDT Relays

G2R-2-S, G2R-2-SN, G2R-2-SNI (S)
 G2R-2-SD, G2R-2-SND, G2R-2-SNDI (S)

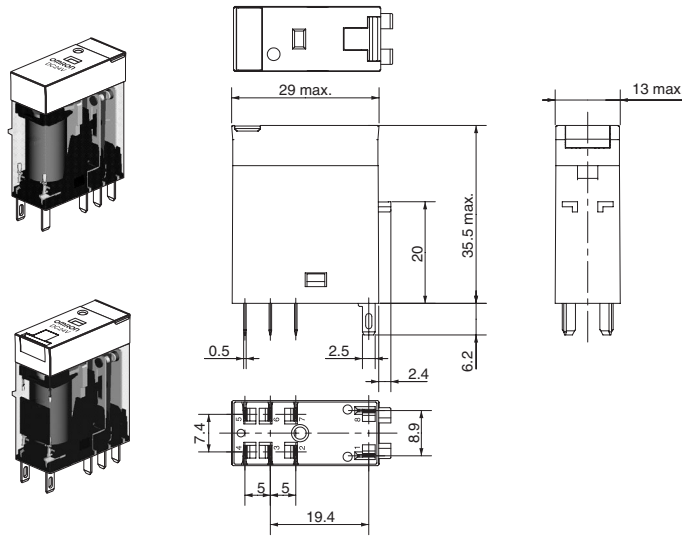

Terminal Arrangement/Internal Connections (Bottom View)

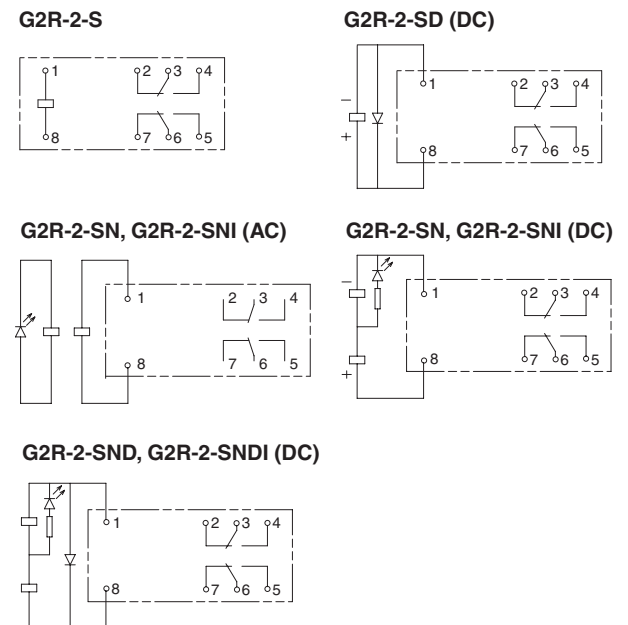

Track/Surface Mounting Sockets

P2RF-05-S

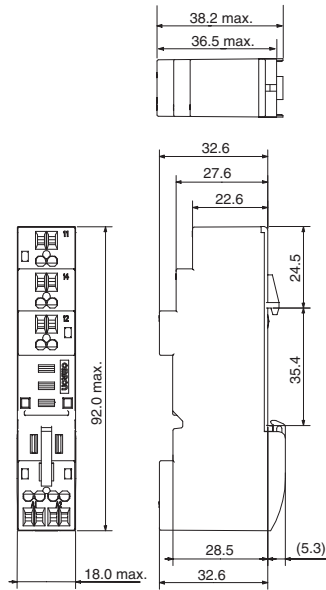
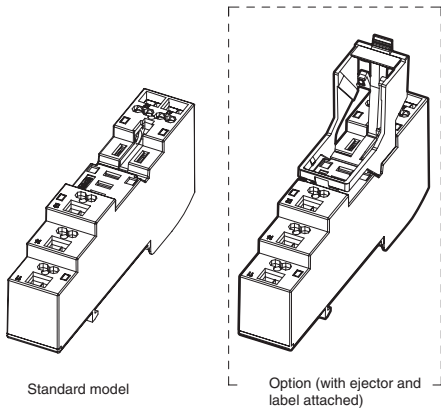

Terminal Arrangement (Top View)

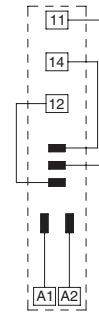

P2RF-08-S

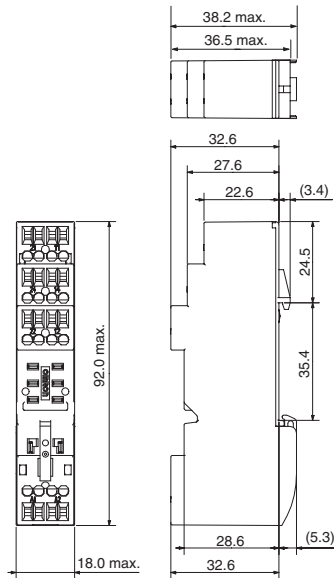
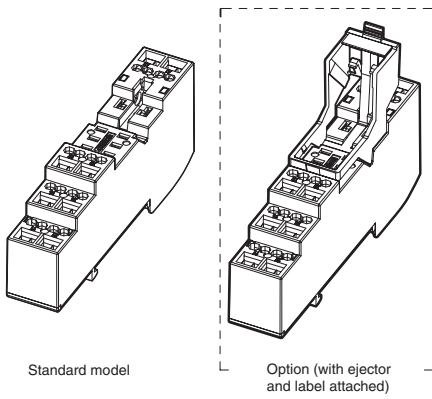

Terminal Arrangement (Top View)

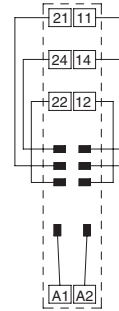

Accessories for P2RF-□-S

Socket Bridge

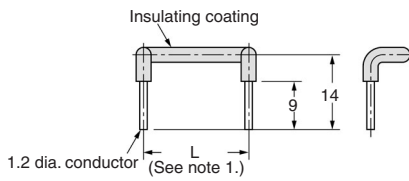

Clip and Release Lever

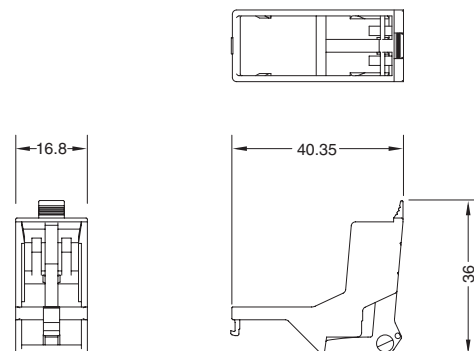

P2RF-05-E

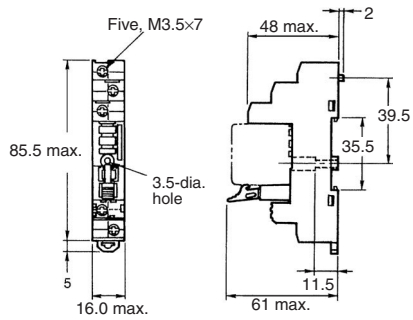
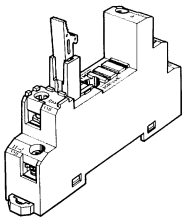

Terminal Arrangement (Top View)

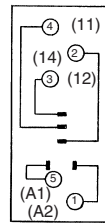

Mounting Holes (for Surface Mounting)

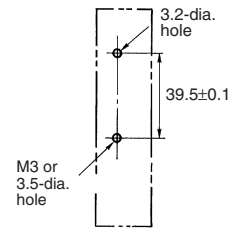

Note: Pin numbers in parentheses apply to DIN standard.

P2RF-08-E

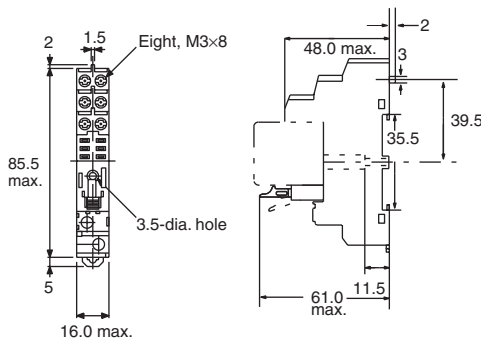
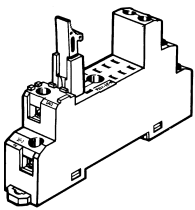

Terminal Arrangement (Top View)

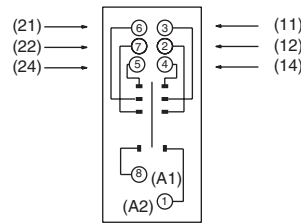

Mounting Holes (for Surface Mounting)

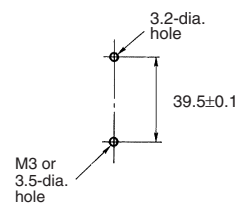

P2RF-05

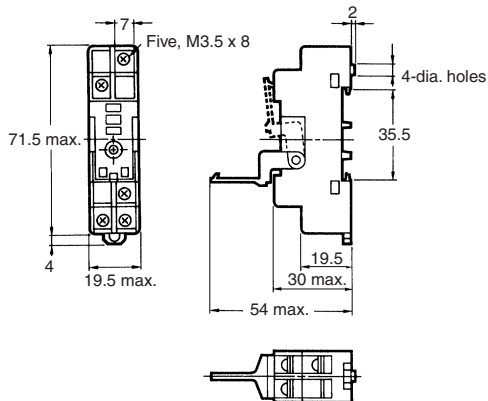
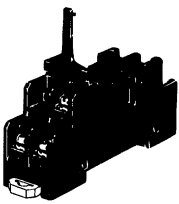

Terminal Arrangement (Top View)

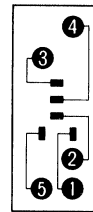

Mounting Holes (for Surface Mounting)

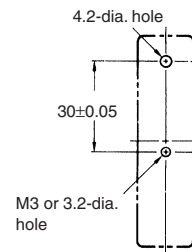

P2RF-08

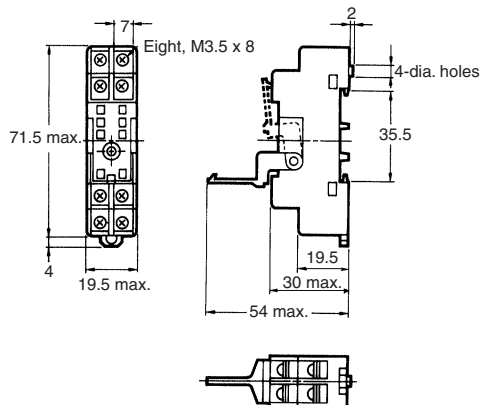
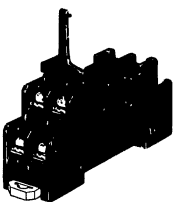

Terminal Arrangement (Top View)

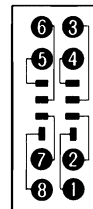

Mounting Holes (for Surface Mounting)

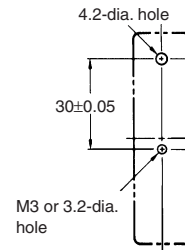

Mounting Height of Relay with Track/Surface Mounting Sockets

P2RF-□

P2RF-□-E

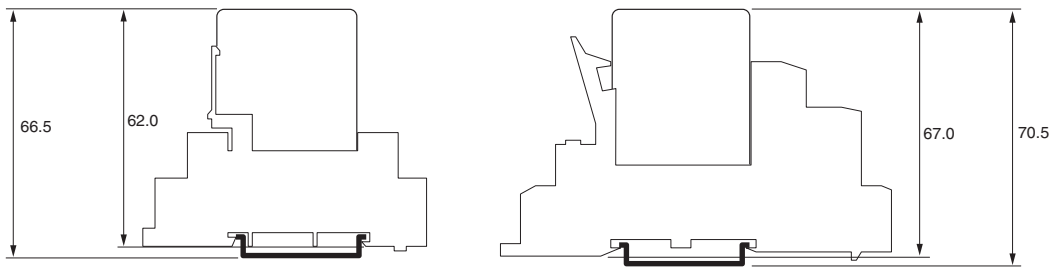

P2RF-□-S

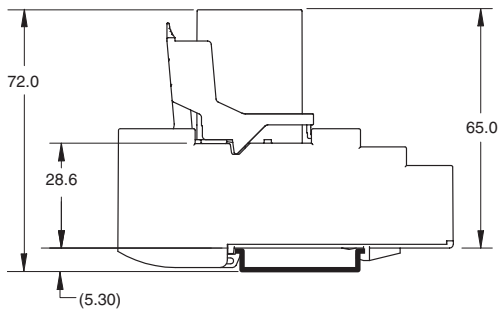

Back-connecting Sockets

P2R-05P (1-pole)

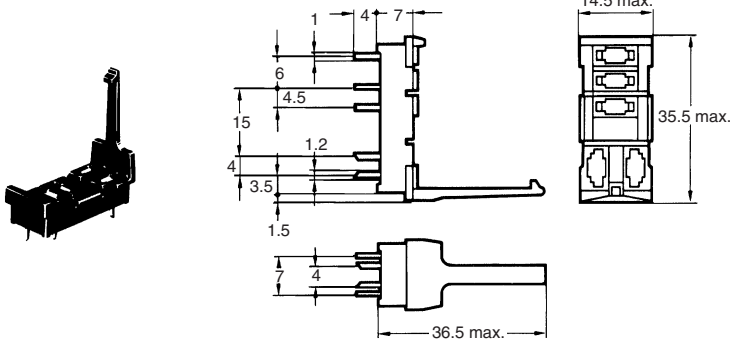

Terminal Arrangement (Bottom View)

Mounting Holes

Tolerance: ± 0.1

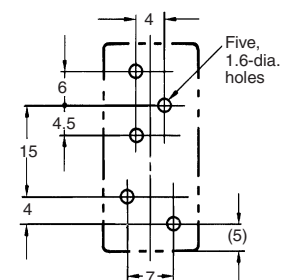

P2R-08P (2-pole)

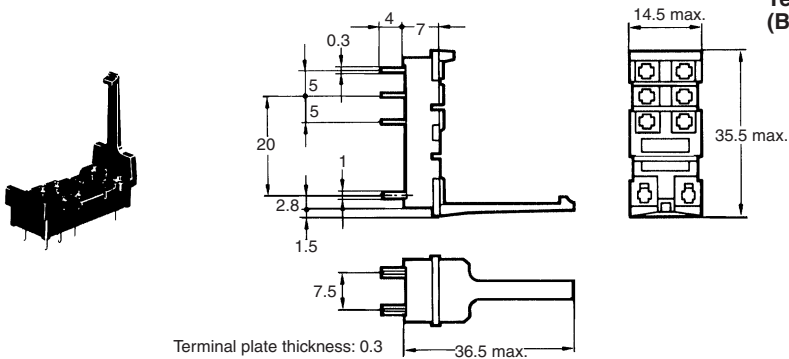

Terminal Arrangement (Bottom View)

Mounting Holes

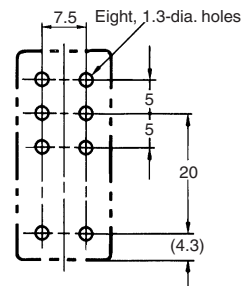

Terminal plate thickness: 0.3

P2R-05A (1-pole)

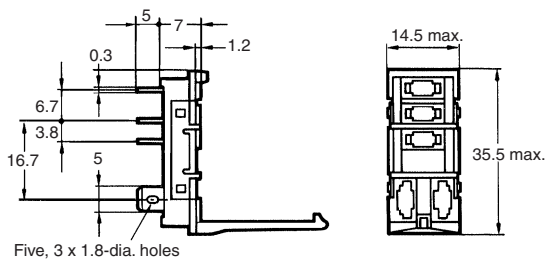
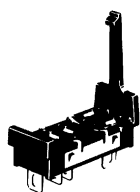

Terminal Arrangement (Bottom View)

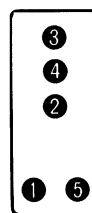

Panel Cutout

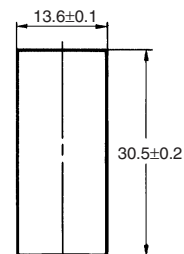

Terminal plate thickness: 0.3

P2R-08A (2-pole)

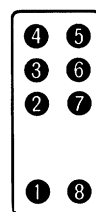
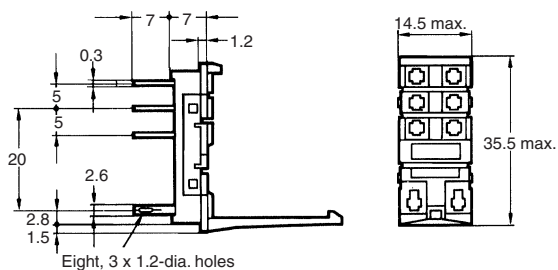
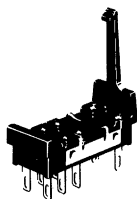

Recommended thickness of the panel is 1.6 to 2.0 mm

Terminal plate thickness: 0.3

P2R-057P

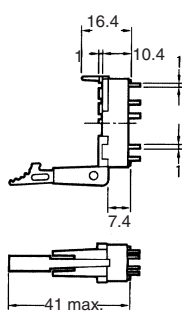
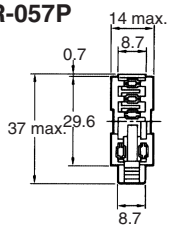

Terminal Arrangement (Bottom View)

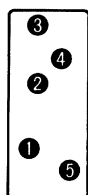

Mounting Holes

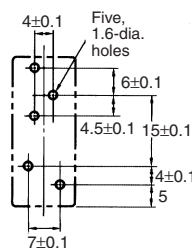

P2R-087P

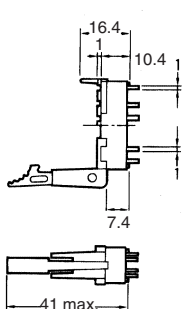
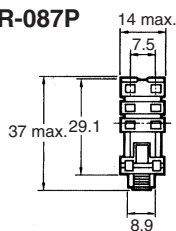

Terminal Arrangement (Bottom View)

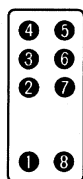

Mounting Holes

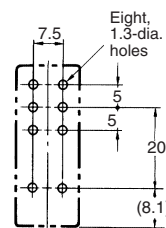

Mounting Height of Relay with Back-connecting Sockets

G2R-□P

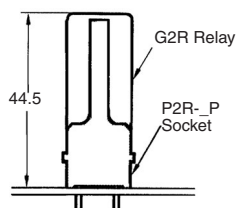

G2R-□A

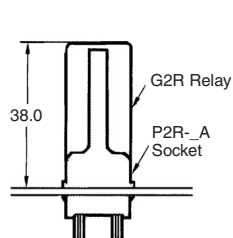

G2R-□7P

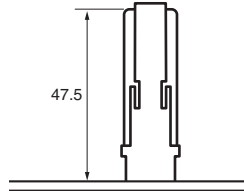

Mounting Tracks

PFP-100N, PFP-50N

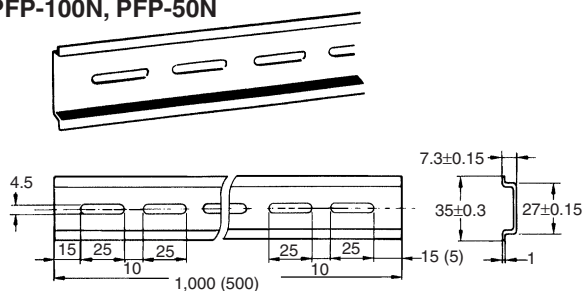

It is recommended to use a panel 1.6 to 2.0 mm thick.

PFP-100N2

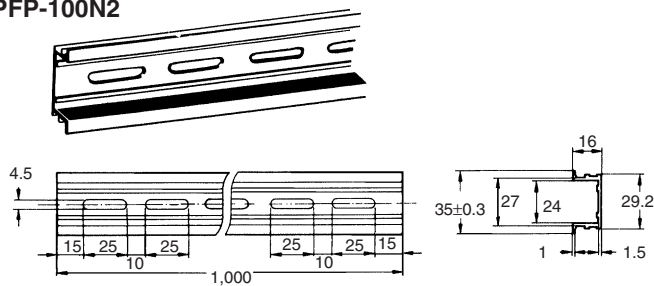

End Plate

PFP-M

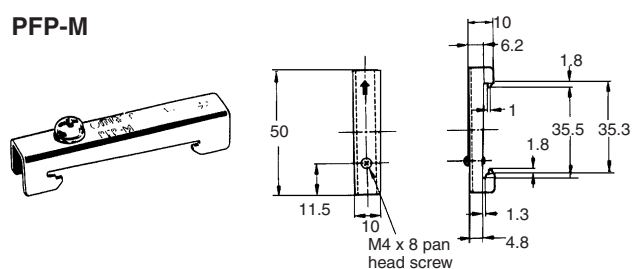

Spacer

PFP-S

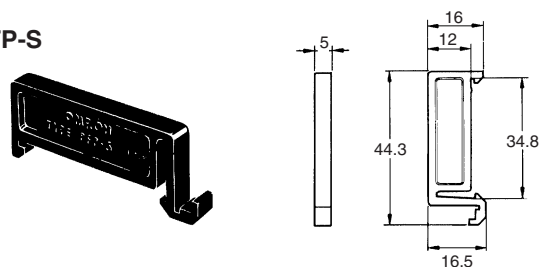

Precautions

⚠ Cation

- Do not use the test button for any purpose other than testing. Be sure not to touch the test button accidentally as this will turn the contacts ON. Before using the test button, confirm that circuits, the load, and any other connected item will operate safely.
- Check that the test button is released before turning ON relay circuits.
- If the test button is pulled out too forcefully, it may bypass the momentary testing position and go straight into the locked position.
- Use an insulated tool when you operate the test button.

Precautions for P2RF-□-S Connection

- Do not move the screwdriver up, down, or from side to side while it is inserted in the hole. Doing so may cause damage to internal components (e.g., deformation of the clamp spring or cracks in the housing) or cause deterioration of insulation.
- Do not insert the screwdriver at an angle. Doing so may break the side of the socket and result in a short-circuit.

Read and Understand This Catalog

Please read and understand this catalog before purchasing the products. Please consult your OMRON representative if you have any questions or comments.

Warranty and Limitations of Liability

WARRANTY

OMRON's exclusive warranty is that the products are free from defects in materials and workmanship for a period of one year (or other period if specified) from date of sale by OMRON.

OMRON MAKES NO WARRANTY OR REPRESENTATION, EXPRESS OR IMPLIED, REGARDING NON-INFRINGEMENT, MERCHANTABILITY, OR FITNESS FOR PARTICULAR PURPOSE OF THE PRODUCTS. ANY BUYER OR USER ACKNOWLEDGES THAT THE BUYER OR USER ALONE HAS DETERMINED THAT THE PRODUCTS WILL SUITABLY MEET THE REQUIREMENTS OF THEIR INTENDED USE. OMRON DISCLAIMS ALL OTHER WARRANTIES, EXPRESS OR IMPLIED.

LIMITATIONS OF LIABILITY

OMRON SHALL NOT BE RESPONSIBLE FOR SPECIAL, INDIRECT, OR CONSEQUENTIAL DAMAGES, LOSS OF PROFITS OR COMMERCIAL LOSS IN ANY WAY CONNECTED WITH THE PRODUCTS, WHETHER SUCH CLAIM IS BASED ON CONTRACT, WARRANTY, NEGLIGENCE, OR STRICT LIABILITY.

In no event shall the responsibility of OMRON for any act exceed the individual price of the product on which liability is asserted.

IN NO EVENT SHALL OMRON BE RESPONSIBLE FOR WARRANTY, REPAIR, OR OTHER CLAIMS REGARDING THE PRODUCTS UNLESS OMRON'S ANALYSIS CONFIRMS THAT THE PRODUCTS WERE PROPERLY HANDLED, STORED, INSTALLED, AND MAINTAINED AND NOT SUBJECT TO CONTAMINATION, ABUSE, MISUSE, OR INAPPROPRIATE MODIFICATION OR REPAIR.

Application Considerations

SUITABILITY FOR USE

OMRON shall not be responsible for conformity with any standards, codes, or regulations that apply to the combination of products in the customer's application or use of the products.

At the customer's request, OMRON will provide applicable third party certification documents identifying ratings and limitations of use that apply to the products. This information by itself is not sufficient for a complete determination of the suitability of the products in combination with the end product, machine, system, or other application or use.

The following are some examples of applications for which particular attention must be given. This is not intended to be an exhaustive list of all possible uses of the products, nor is it intended to imply that the uses listed may be suitable for the products:

- Outdoor use, uses involving potential chemical contamination or electrical interference, or conditions or uses not described in this catalog.
- Nuclear energy control systems, combustion systems, railroad systems, aviation systems, medical equipment, amusement machines, vehicles, safety equipment, and installations subject to separate industry or government regulations.
- Systems, machines, and equipment that could present a risk to life or property.

Please know and observe all prohibitions of use applicable to the products.

NEVER USE THE PRODUCTS FOR AN APPLICATION INVOLVING SERIOUS RISK TO LIFE OR PROPERTY WITHOUT ENSURING THAT THE SYSTEM AS A WHOLE HAS BEEN DESIGNED TO ADDRESS THE RISKS, AND THAT THE OMRON PRODUCTS ARE PROPERLY RATED AND INSTALLED FOR THE INTENDED USE WITHIN THE OVERALL EQUIPMENT OR SYSTEM.

PROGRAMMABLE PRODUCTS

OMRON shall not be responsible for the user's programming of a programmable product, or any consequence thereof.

Disclaimers

CHANGE IN SPECIFICATIONS

Product specifications and accessories may be changed at any time based on improvements and other reasons.

It is our practice to change model numbers when published ratings or features are changed, or when significant construction changes are made. However, some specifications of the products may be changed without any notice. When in doubt, special model numbers may be assigned to fix or establish key specifications for your application on your request. Please consult with your OMRON representative at any time to confirm actual specifications of purchased products.

DIMENSIONS AND WEIGHTS

Dimensions and weights are nominal and are not to be used for manufacturing purposes, even when tolerances are shown.

PERFORMANCE DATA

Performance data given in this catalog is provided as a guide for the user in determining suitability and does not constitute a warranty. It may represent the result of OMRON's test conditions, and the users must correlate it to actual application requirements. Actual performance is subject to the OMRON Warranty and Limitations of Liability.

ERRORS AND OMISSIONS

The information in this document has been carefully checked and is believed to be accurate; however, no responsibility is assumed for clerical, typographical, or proofreading errors, or omissions.

2009.7

In the interest of product improvement, specifications are subject to change without notice.

OMRON Corporation
Industrial Automation Company

<http://www.ia.omron.com/>

(c)Copyright OMRON Corporation 2009 All Right Reserved.